











Légende

-  Purgeur
-  Clapet Anti-retour
-  Circulateur
-  Sonde T° Capteur ou ensoleillement
-  Vanne normalement ouverte
-  Vanne normalement fermée
-  Vase d'expansion
-  Sonde T° Haut de ballon
-  Sonde T° bas de ballon ou retour échangeur

Référence		Groupe de schéma	No. d'article/Référence
Dessiné par JC	Vérifié par FG	Approuvé par - date	Date 18/05/2015
		<h2>Systèmes solaires collectifs autovidangeable / sous pression</h2>	

Système Autovidangeable

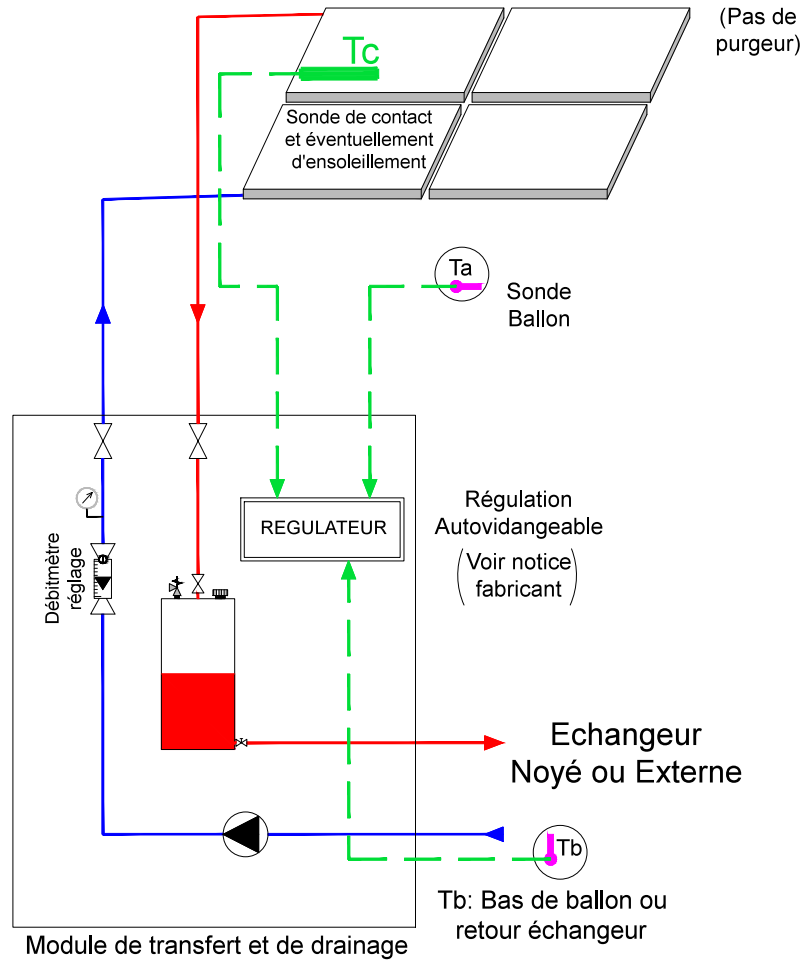

Système Sous pression

